

ZIER- UND RELIEFEISEN
DES
FASSONEISEN -WALZWERKES
L. MANNSTAEDT & CO., AKT. = GES.
IN
TROISDORF BEI KÖLN

ZIER- UND RELIEFFESEN

DES

FASSONREISEN-WALZWERKES

L. MANNSTADT & CO. AKT. - GES.

IN

THROSDORF BEI KÖLN

WM. SZALAY & SOHN, WIEN

Geländer- und Säulenisen

Gewundenes Kreuzeisen

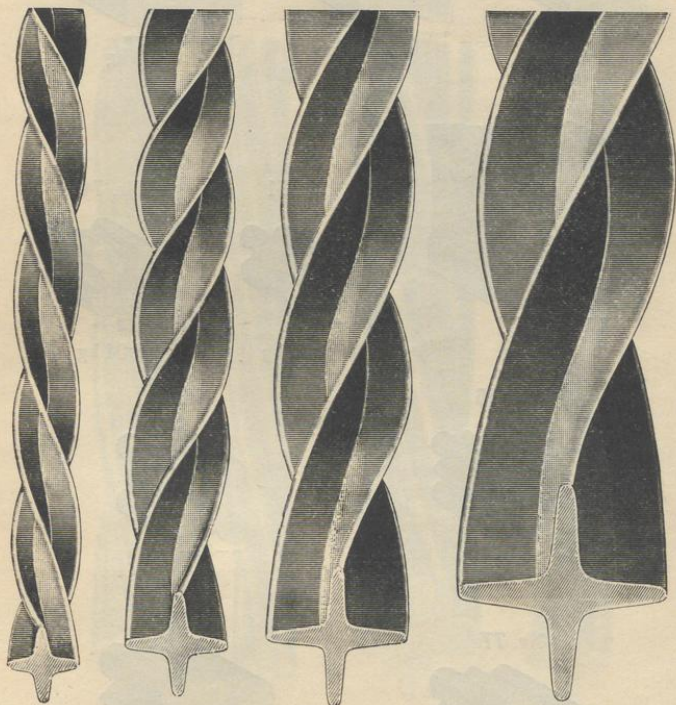

Geländer- und Säuleneisen

Nr. 59

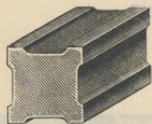

←20→
2·60 kg

Nr. 60

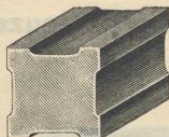

←25→
4·20 kg

Nr. 61

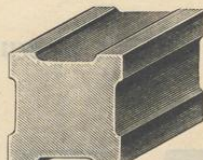

←30→
6·00 kg

Nr. 62

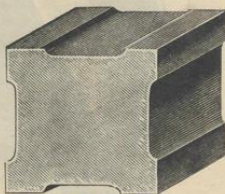

←40→
10·90 kg

Nr. 71



←15→
1·35 kg

Nr. 74



←19→
2·04 kg

Nr. 76



←20→
2·78 kg

Nr. 75

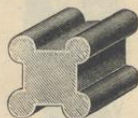

←22→
2·71 kg

Nr. 77

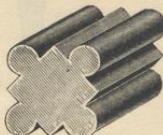

←25→
4·40 kg

Nr. 78

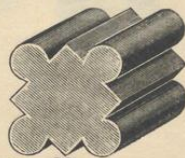

←30→
6·20 kg

WM. SZALAY & SOHN, WIEN

**Gewundenes Geländer- und
Säuleneisen**

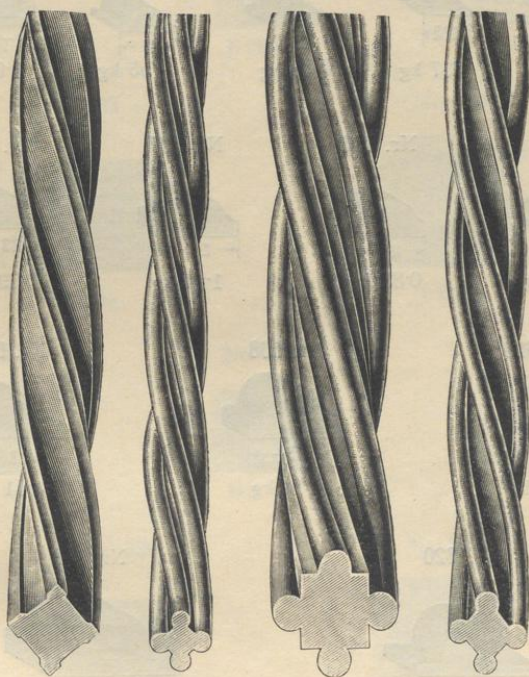

Bundeisen

Nr. 28



0.25 kg

Nr. 29



0.37 kg

Nr. 32



0.46 kg

Nr. 30



0.55 kg

Nr. 505



0.67 kg

Nr. 31



0.66 kg

Nr. 506



0.89 kg

Nr. 507



1.24 kg

Nr. 617



0.79 kg

Nr. 618



1.12 kg

Nr. 508



1.84 kg

Nr. 619

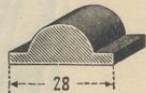

1.41 kg

Nr. 620



2 kg

Nr. 172

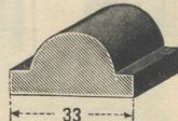

3 kg

Verzierte Querleisteneisen

Nr. 600



0·8 kg

Nr. 601



0·96 kg

Nr. 602

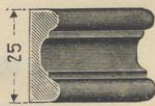

1·06 kg

Nr. 603

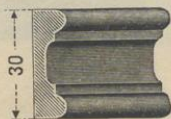

1·14 kg

Nr. 604

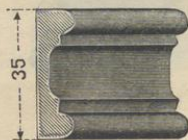

1·46 kg

Nr. 314



0·73 kg

Nr. 316



0·8 kg

Nr. 318



0·97 kg

Nr. 320

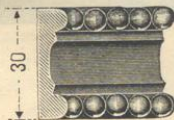

1·22 kg

Nr. 322

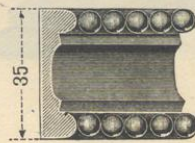

1·55 kg

Verzierte Türschlageisteneisen

Nr. 605

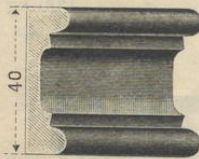

2.1 kg

Nr. 606

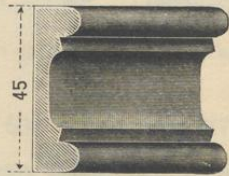

2.56 kg

Nr. 607

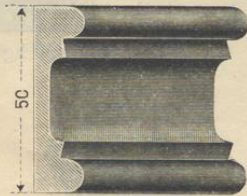

3.16 kg

Nr. 756

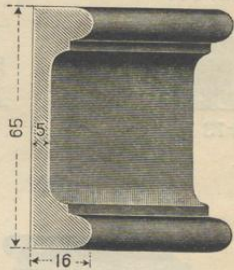

4.1 kg

Verzierte Türschlageisen

Nr. 324

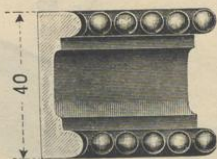

1.86 kg

Nr. 326

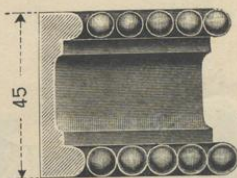

2.41 kg

Nr. 2023

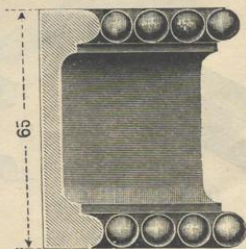

4.04 kg

Nr. 328

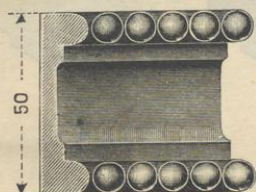

2.88 kg

Verzierte Deckleisteneisen

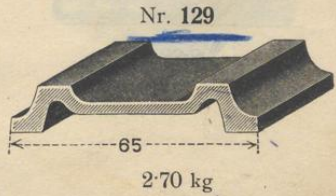
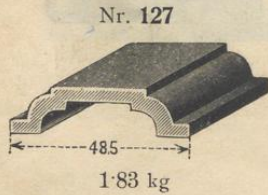
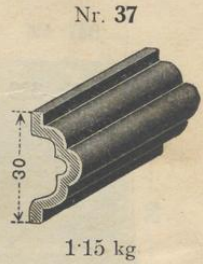
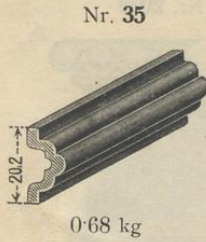
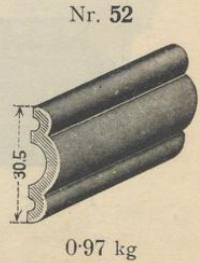
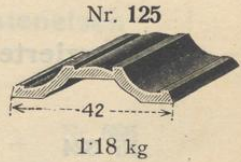
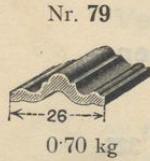

Verzierte Deckleisteneisen

Nr. 777



0.3 kg

Nr. 779



0.4 kg

Nr. 780



0.55 kg

Nr. 509



0.64 kg

Nr. 510

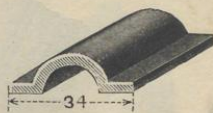

0.8 kg

Nr. 511

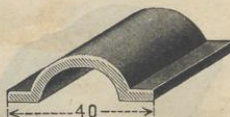

1 kg

Nr. 671

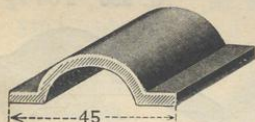

1.2 kg

Nr. 672

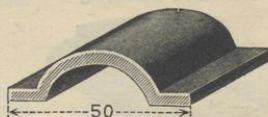

1.46 kg

Nr. 1752

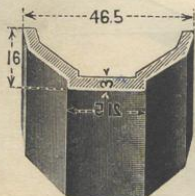

1.35 kg

Nr. 1750

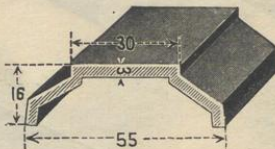

1.55 kg

WM. SZALAY & SOHN, WIEN

Verzierte Handleisteneisen

Nr. 805 3.50 kg

Nr. 65 3.05 kg

Nr. 66 3.33 kg

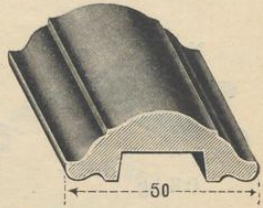
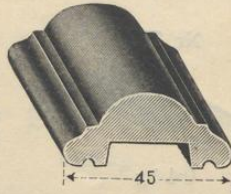
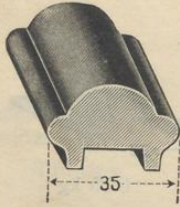

Nr. 67 4.55 kg

Nr. 68 5.80 kg

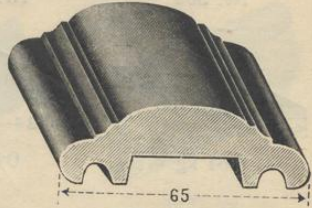
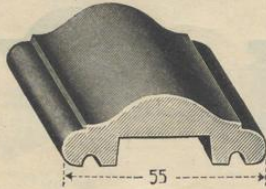

Nr. 1044 1.86 kg

Nr. 990 2.56 kg

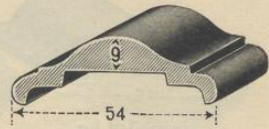
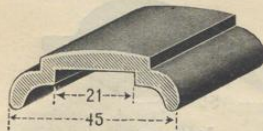

Nr. 1045 2.1 kg

Nr. 991 3.15 kg

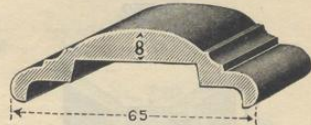
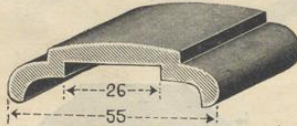

Nr. 1046 2.86 kg

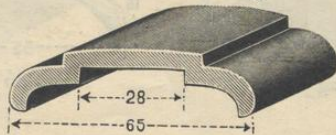

Zierwinkleisen

Nr. 543 1.90 kg Nr. 544 2.28 kg Nr. 668 1.38 kg Nr. 669 1.70 kg

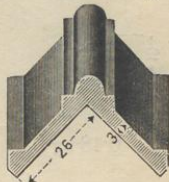
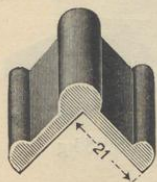

Nr. 54 1.85 kg

Nr. 55 1.68 kg

Nr. 56 3.48 kg

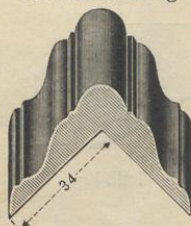
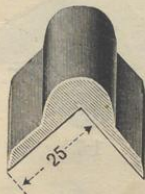

Nr. 550 0.97 kg

Nr. 551 1.2 kg

Nr. 552 1.66 kg

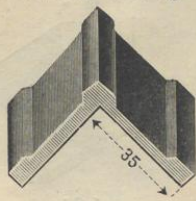

Nr. 553 2.56 kg

Nr. 554 2.73 kg

Nr. 555 3.2 kg

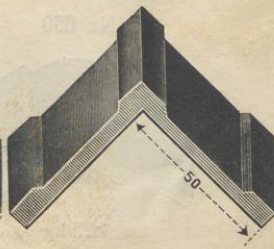
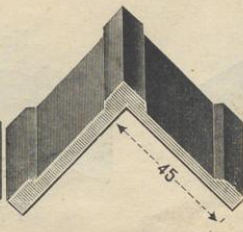
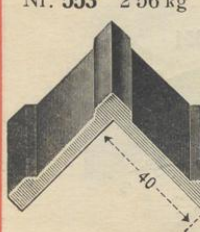

Ziereisen

Nr. 523



0.48 kg

Nr. 524



0.63 kg

Nr. 525



0.9 kg

Nr. 526



0.98 kg

Nr. 527

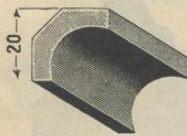

1.25 kg

Nr. 528

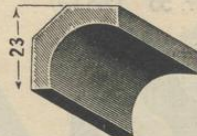

1.52 kg

Nr. 529

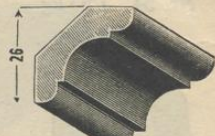

1.7 kg

Nr. 534

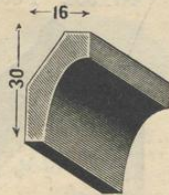

1.6 kg

Nr. 649

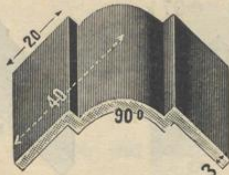

1.75 kg

Nr. 650



1.75 kg

Nr. 651

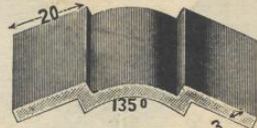

1.75 kg

Ziereisen

Nr. 175

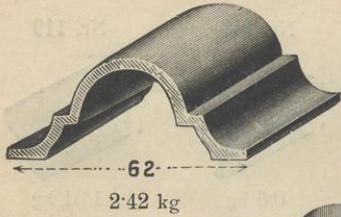

Nr. 176

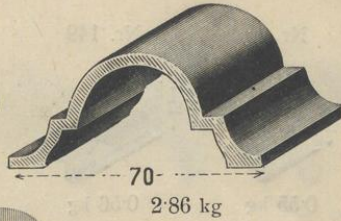

Nr. 562

2.2 kg

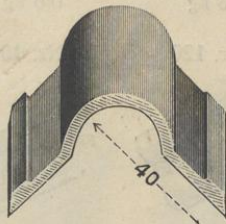

Nr. 103

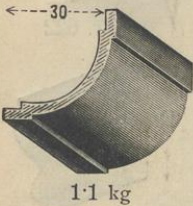

Nr. 104

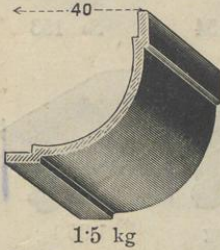

Nr. 105



Nr. 102 1.68 kg

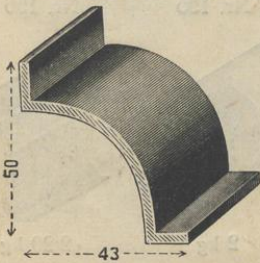

Nr. 101 1.1 kg

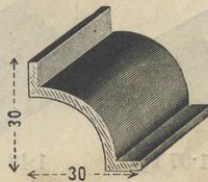

Ziereisen

Nr. 1



0.55 kg

Nr. 149



0.56 kg

Nr. 148

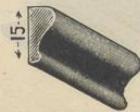

0.6 kg

Nr. 119

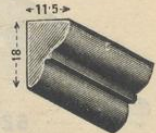

1.01 kg

Nr. 44

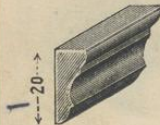

0.91 kg

Nr. 120

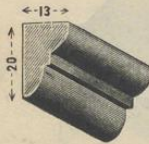

1.25 kg

Nr. 150

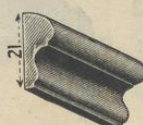

0.95 kg

Nr. 151

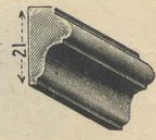

1.05 kg

Nr. 45

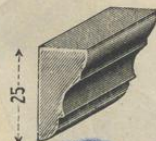

1.6 kg

Nr. 154



1.38 kg

Nr. 153

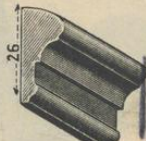

1.35 kg

Nr. 622



1.64 kg

Nr. 152



1.07 kg

Nr. 138



1.48 kg

Nr. 155

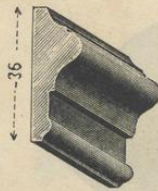

2 kg

Nr. 156

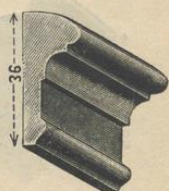

2.20 kg

Ziereisen

Nr. 751

Nr. 1031



0.28 kg

Nr. 517

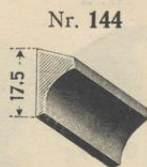

0.6 kg

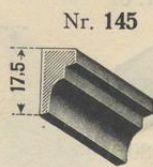

0.65 kg



0.77 kg

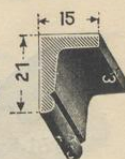

0.83 kg

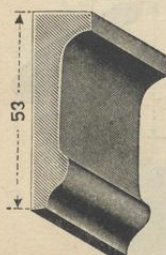

3.2 kg

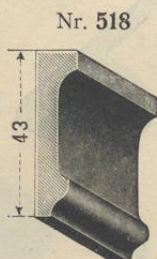

2.37 kg

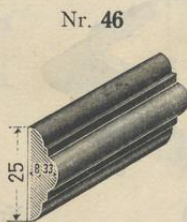

1.07 kg

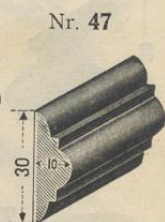

1.4 kg

Nr. 49

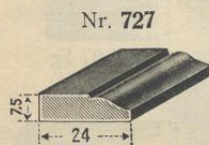

1.04 kg

Nr. 739

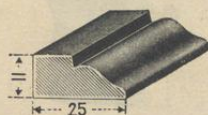

1.6 kg



1.62 kg

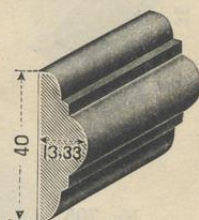

2.46 kg

Nr. 1186

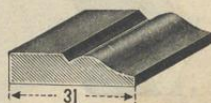

1.72 kg

Ziereisen

Nr. 86



0.51 kg

Nr. 87



0.80 kg

Nr. 2



0.59 kg

Nr. 3



0.58 kg

Nr. 11



1.15 kg

Nr. 89



0.8 kg

Nr. 112

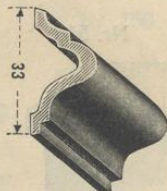

1.06 kg

Nr. 12

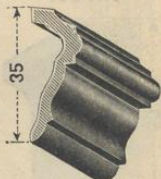

1.5 kg

Nr. 90

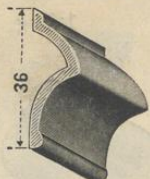

1.03 kg

Nr. 91

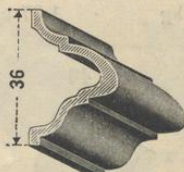

1.62 kg

Nr. 704



0.97 kg

Nr. 705

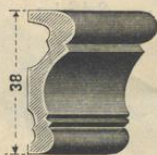

1.5 kg

Nr. 706

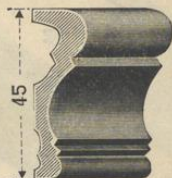

2.06 kg

Nr. 707

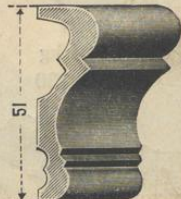

2.26 kg

Ziereisen

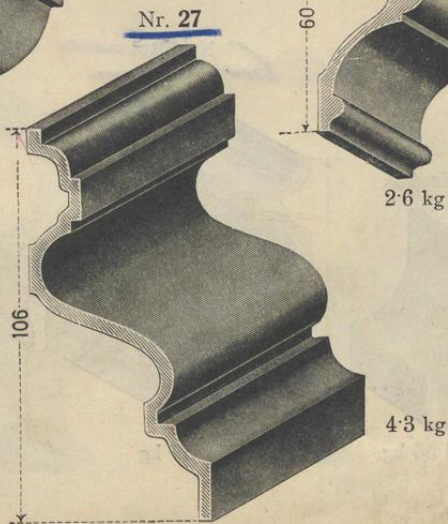
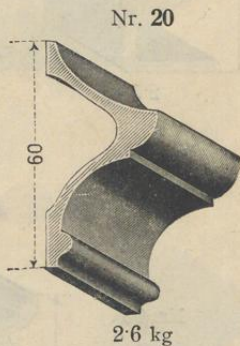
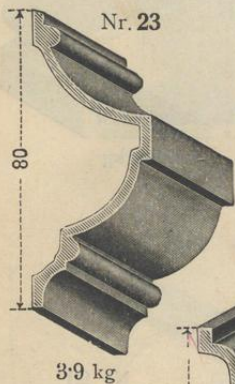
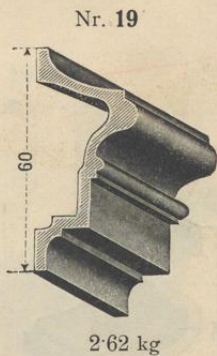
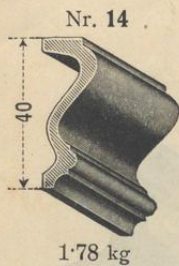

Ziereisen

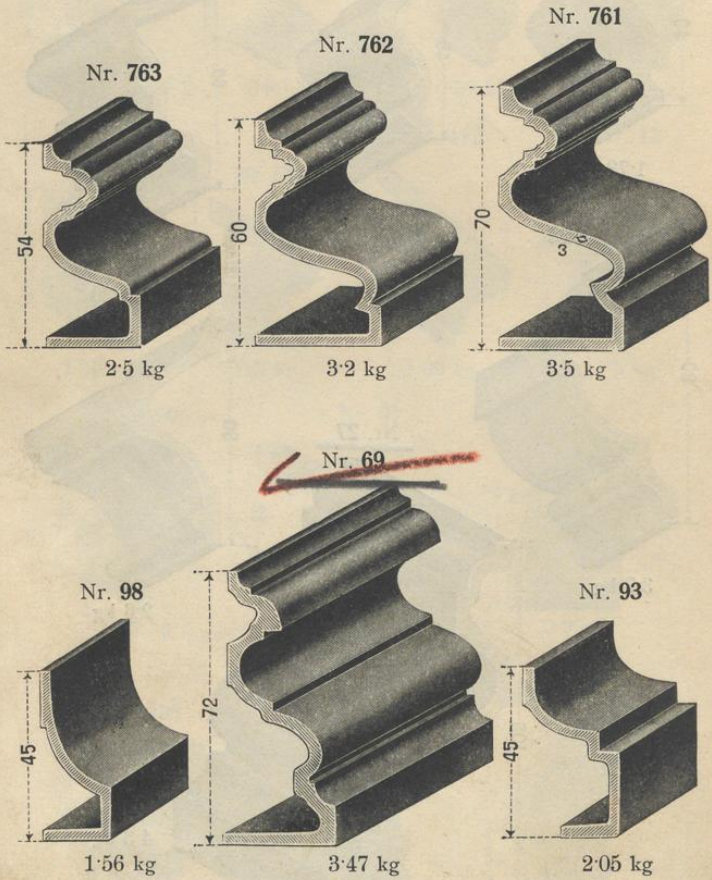

Ziereisen

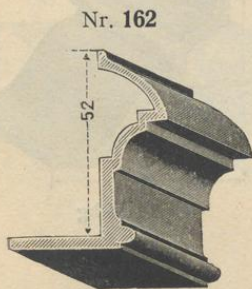

2.56 kg

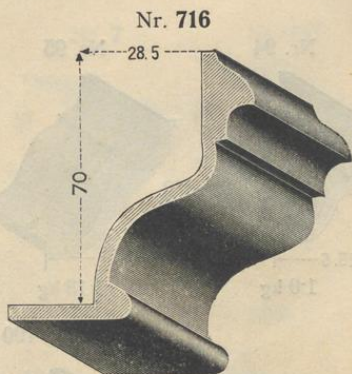

3.76 kg

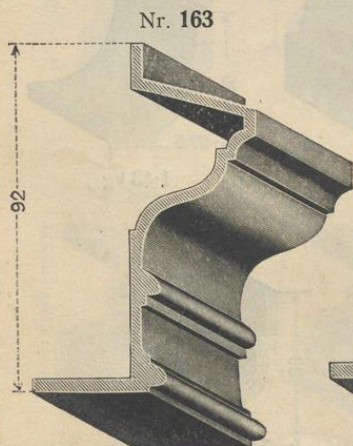

4.92 kg

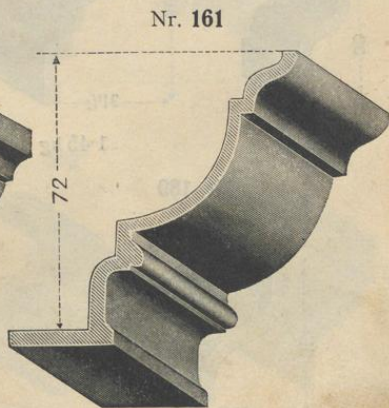

4.70 kg

Ziereisen

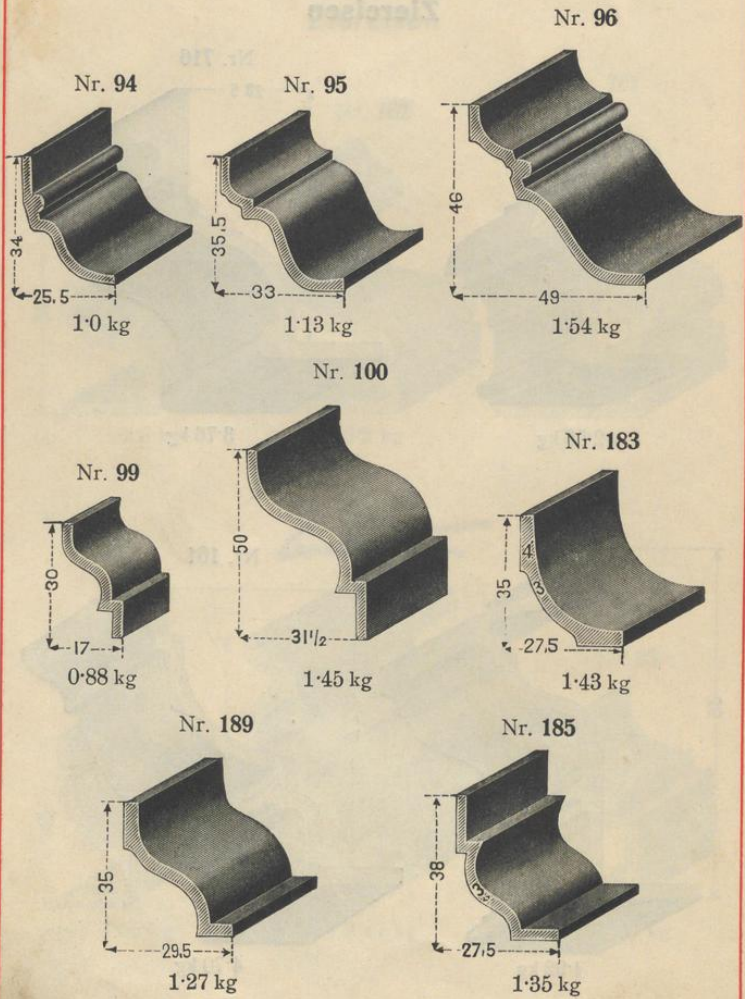

Ziereisen

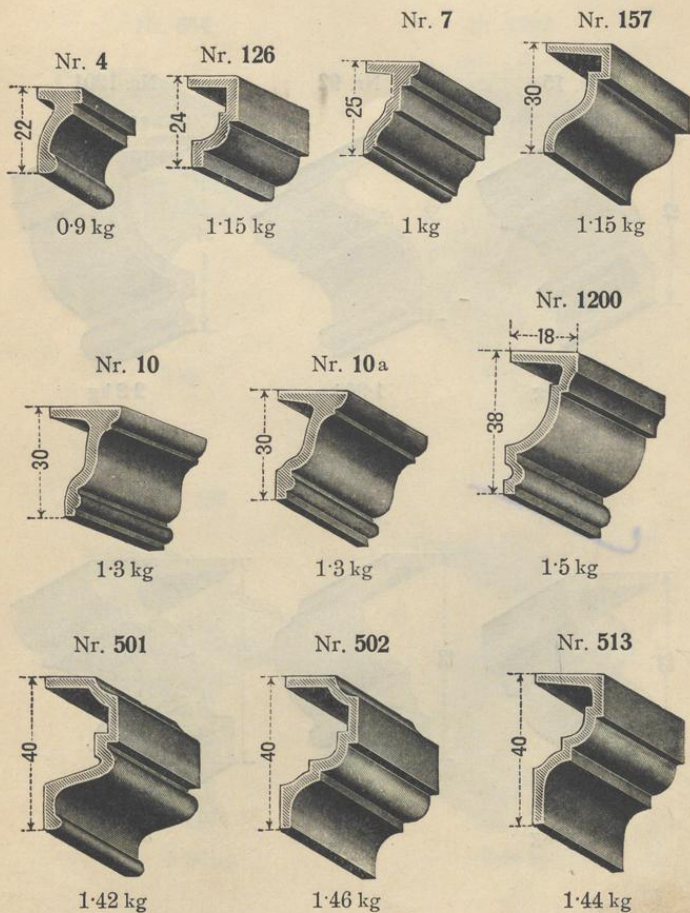

Ziereisen

Nr. 15

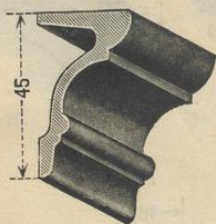

2.12 kg

Nr. 92

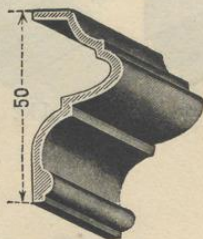

1.95 kg

Nr. 1201

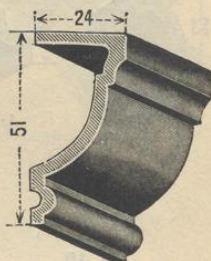

2.2 kg

Nr. 514

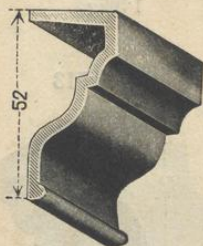

2.06 kg

Nr. 17

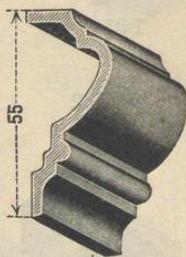

2.2 kg

Nr. 18

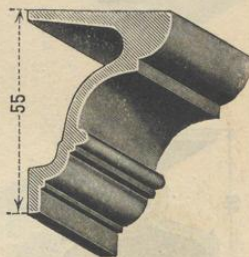

3.6 kg

Ziereisen

Nr. 654

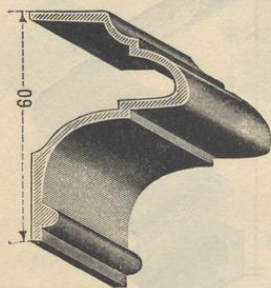

3 kg

Nr. 1202

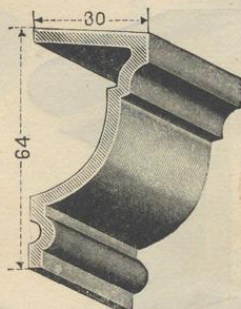

3.15 kg

Nr. 158

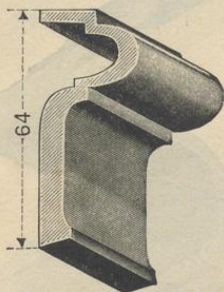

3.86 kg

Nr. 21

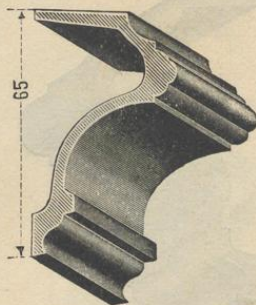

3.48 kg

Ziereisen

Nr. 159

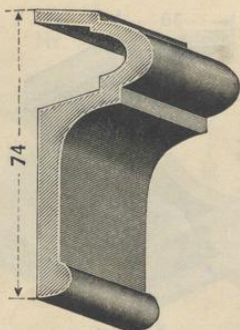

4·86 kg

Nr. 758

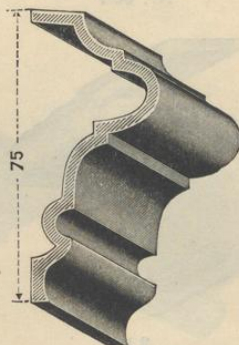

3·12 kg

Nr. 757

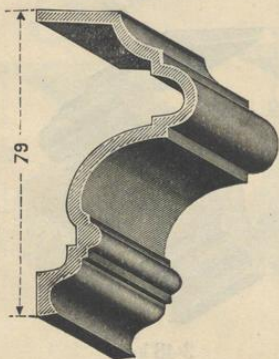

3·9 kg

Nr. 655

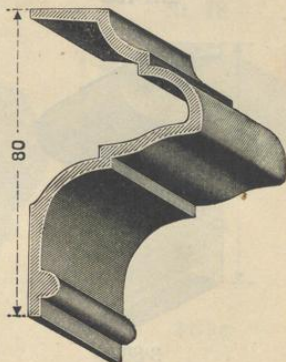

4·1 kg

Ziereisen

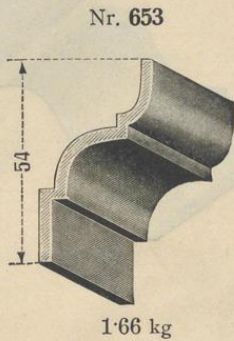
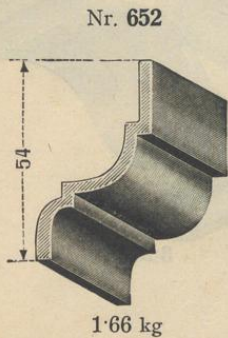
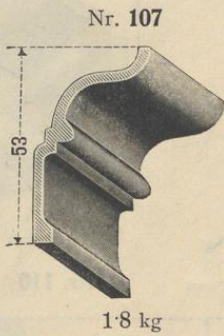
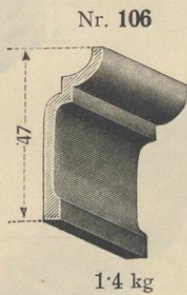
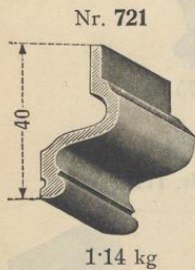
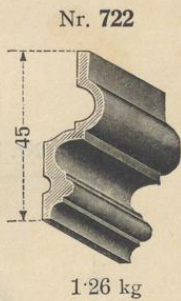
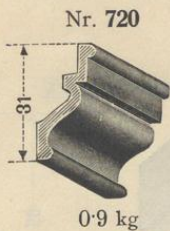
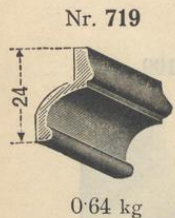

Ziereisen

Nr. 108

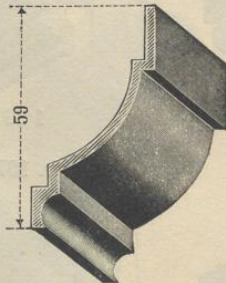

1.75 kg

Nr. 109

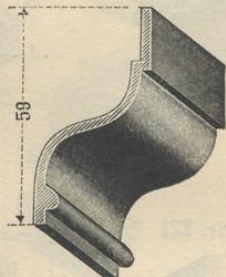

1.75 kg

Nr. 110

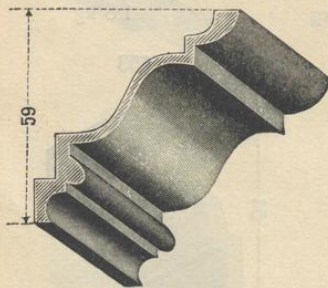

2.5 kg

Nr. 111

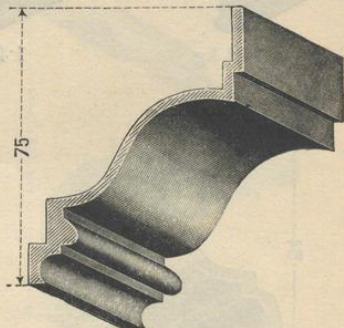

3.25 kg

Ziereisen

Nr. 24

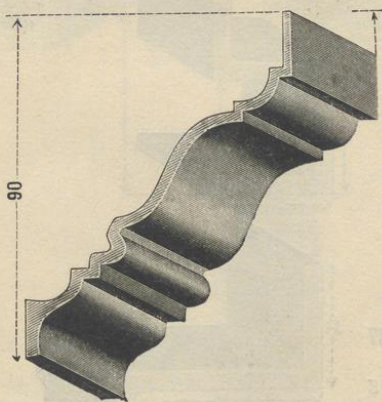

4.2 kg

Spezialeisen
für Schaufenster-Anlagen

Nr. 186

7.50 kg

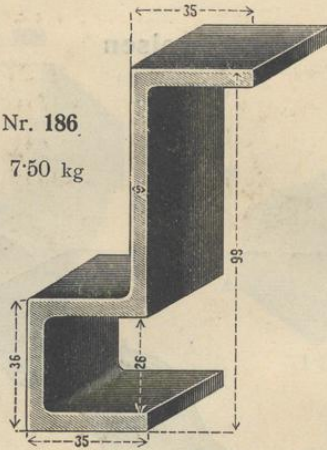

Nr. 187

6.80 kg

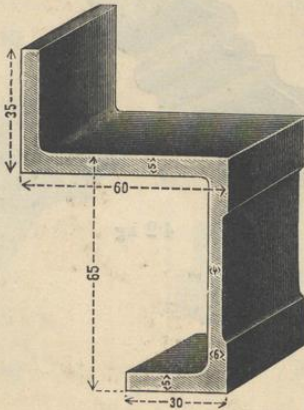

WM. SZALAY & SOHN, WIEN

Spezialeisen für Schaufenster-Anlagen

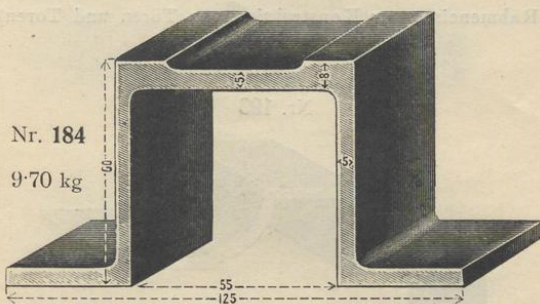

Nr. 188
7.30 kg

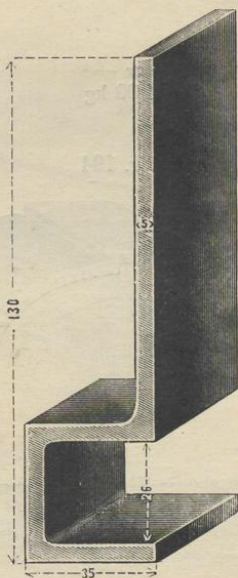

Ziereisen

(Rahmeneisen zur Konstruktion von Türen und Toren)

Nr. 193

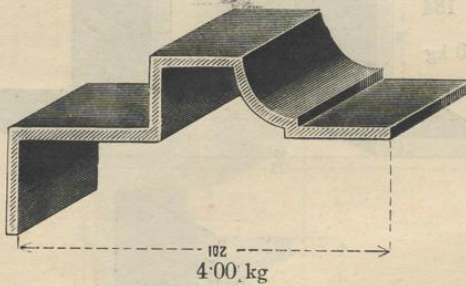

Nr. 194

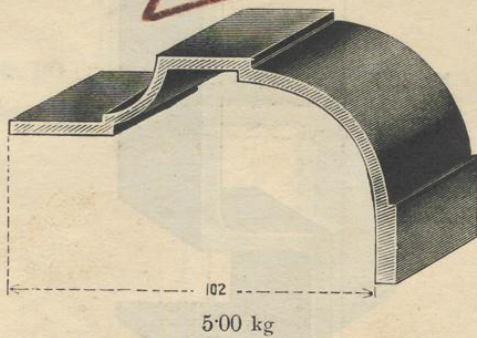

Reliefeisen

Nr. 1517

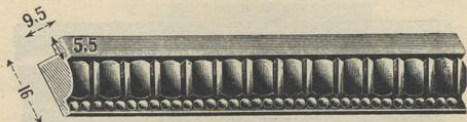

0.78 kg

Nr. 251



0.85 kg

Nr. 252

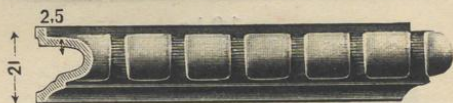

1 kg

Nr. 1575

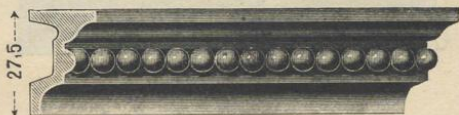

1.27 kg

Nr. 428

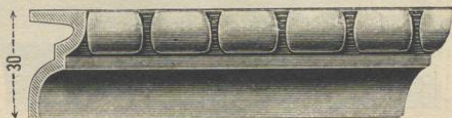

1.2 kg

WM. SZALAY & SOHN, WIEN

Reliefeisen

Nr. 1577



1.2 kg

Nr. 253

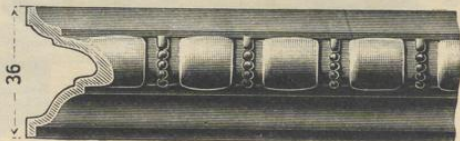

1.9 kg

Nr. 830

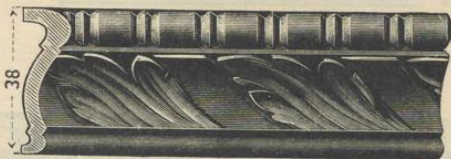

1.72 kg

Nr. 423

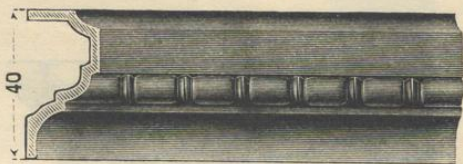

1.56 kg

Reliefeisen

Nr. 1153



1.00 kg

Nr. 1156



1.56 kg

Nr. 1157



2.44 kg

Nr. 1158

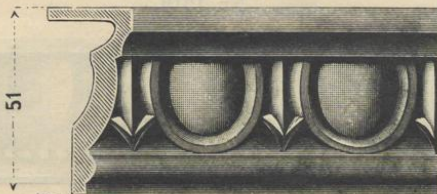

2.8 kg

WM. SZALAY & SOHN, WIEN

Reliefeisen

Nr. 1159

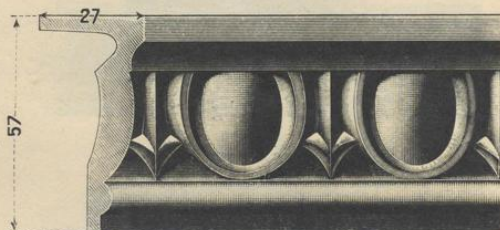

3.9 kg

Nr. 1160

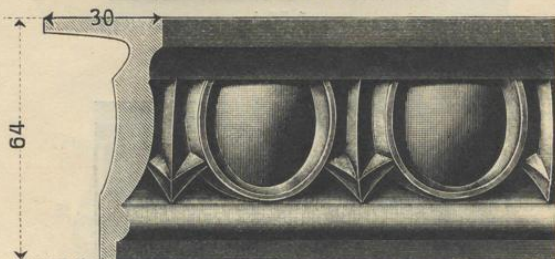

4.52 kg

Nr. 1516

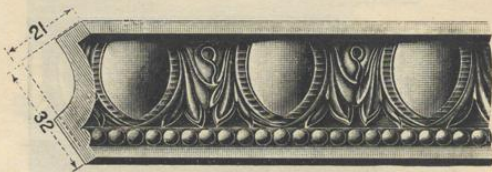

1.45 kg

Reliefeisen

Nr. 425

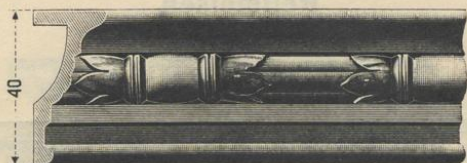

2.44 kg

Nr. 427

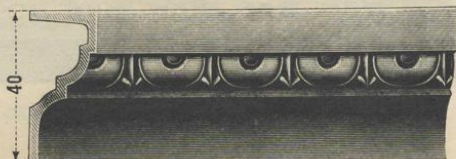

1.55 kg

Nr. 269

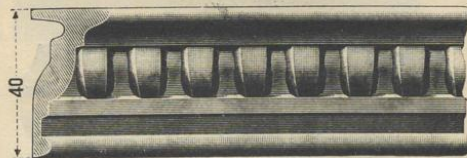

2.29 kg

Nr. 1579

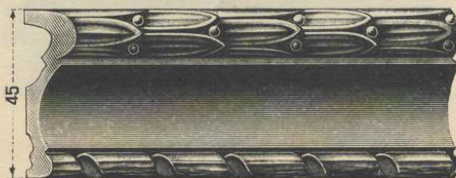

1.72 kg

WM. SZALAY & SOHN, WIEN

Reliefeisen

Nr. 221

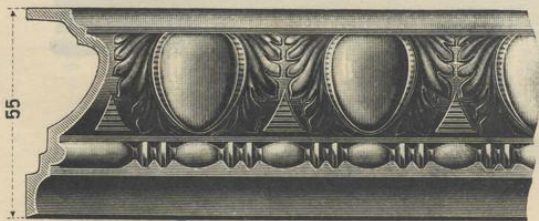

2.32 kg

Nr. 222

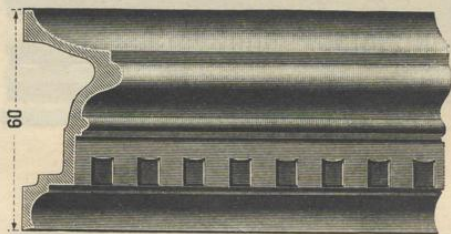

2.56 kg

Reliefeisen

Nr. 255

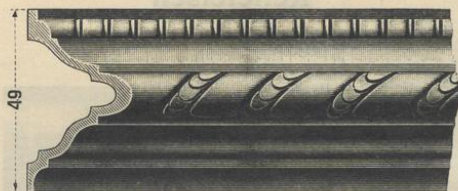

1.85 kg

Nr. 256

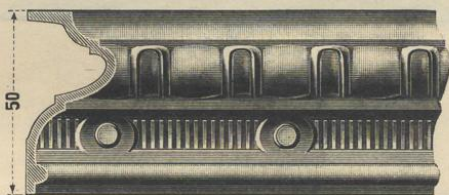

2.2 kg

Nr. 1580

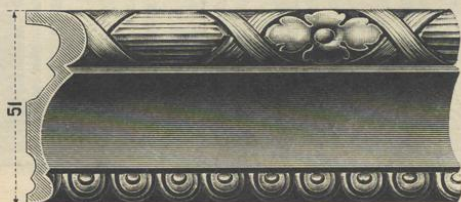

1.96 kg

Reliefeisen

Nr. 295

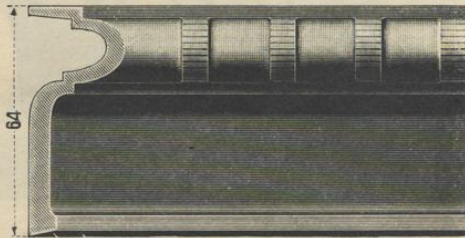

4.04 kg

Nr. 1728

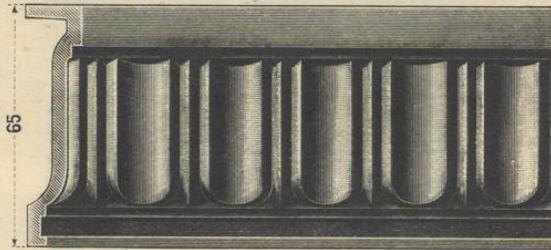

2.3 kg

Reliefeisen

Nr. 426

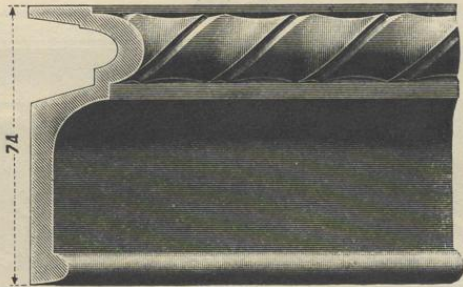

4.61 kg

Nr. 300



4.4 kg

WM. SZALAY & SOHN, WIEN

Reliefeisen

Nr. 232

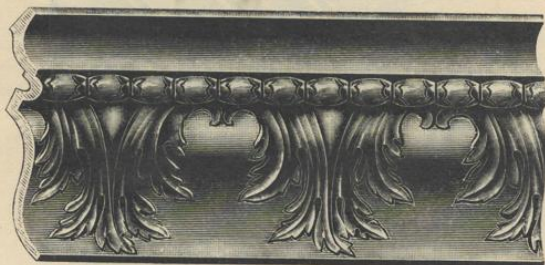

1.85 kg

Nr. 257

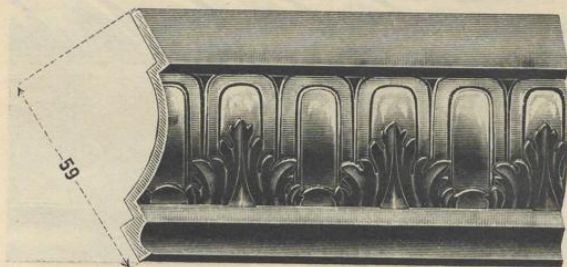

2.1 kg

Reliefeisen

Nr. 447



0.19 kg

Nr. 429



0.28 kg

Nr. 448



0.27 kg

Nr. 430



0.38 kg

Nr. 449



0.32 kg

Nr. 431



0.56 kg

Nr. 450



0.44 kg

Nr. 455

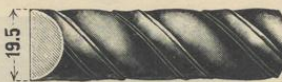

1.02 kg

Nr. 453



1.03 kg

Nr. 459



1.20 kg

Reliefeisen

Nr. 201



0.37 kg

Nr. 282



0.5 kg

Nr. 202



0.43 kg

Nr. 206



0.72 kg

Nr. 283



0.72 kg

Nr. 204



0.6 kg

Nr. 398



0.74 kg

Nr. 224



0.6 kg

Nr. 297



1 kg

Nr. 284



1.14 kg

Reliefeisen

Nr. 1740

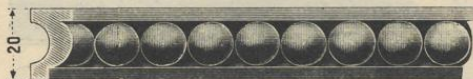

1.0 kg

Nr. 1741

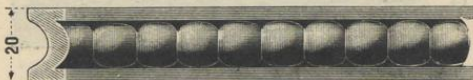

1.16 kg

Nr. 1742



0.9 kg

Nr. 1743



1.14 kg

Nr. 1744



0.9 kg

WM. SZALAY & SOHN, WIEN

Reliefeisen

Nr. 210



0·85 kg

Nr. 399



0·84 kg

Nr. 208

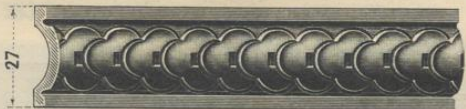

0·73 kg

Nr. 215

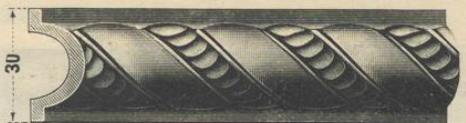

1·12 kg

Nr. 418



1·25 kg

Reliefeisen

Nr. 298



1.2 kg

Nr. 401

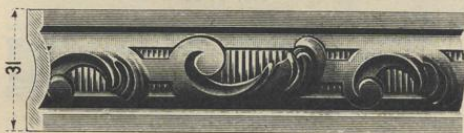

0.91 kg

Nr. 417



0.96 kg

Nr. 217

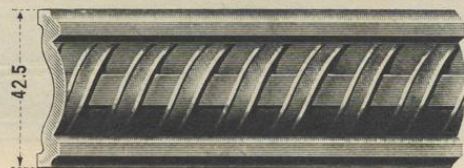

1.65 kg

Reliefeisen

Nr. 1745

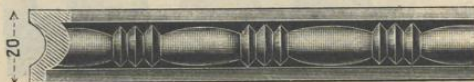

1.1 kg

Nr. 1746

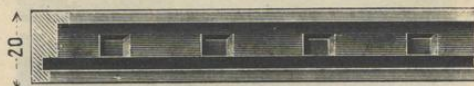

0.97 kg

Nr. 1733



1.2 kg

Nr. 1736

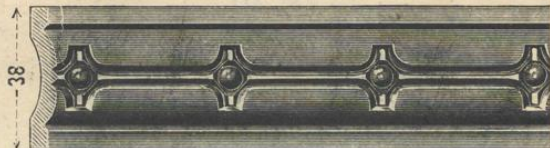

1.3 kg

Reliefeisen

Nr. 1730

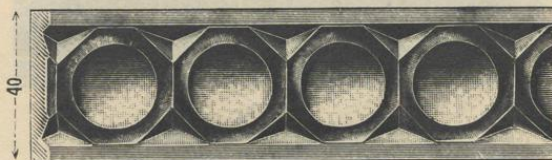

1.42 kg

Nr. 1731



1.4 kg

Nr. 1732



1.4 kg

WM. SZALAY & SOHN, WIEN

Reliefeisen

Nr. 1735

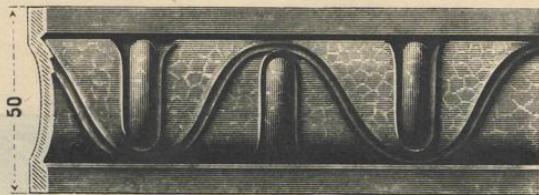

1.76 kg

Nr. 1729

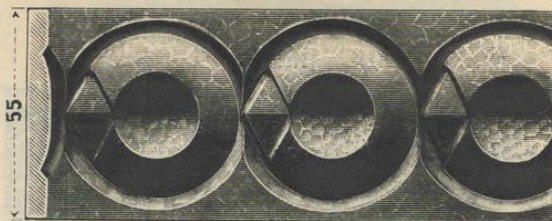

1.9 kg

Nr. 1734

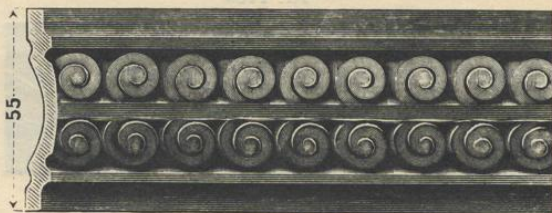

2.2 kg

Reliefeisen

Nr. 214

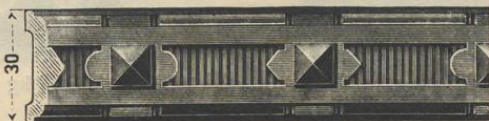

0.92 kg

Nr. 213



1.1 kg

Nr. 400



0.88 kg

Nr. 307



1.45 kg

Reliefeisen

Nr. 205



0.53 kg

Nr. 209

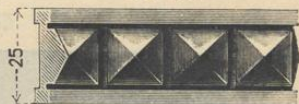

0.69 kg

Nr. 212



1.02 kg

Nr. 272

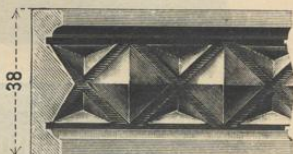

2.12 kg

Nr. 273

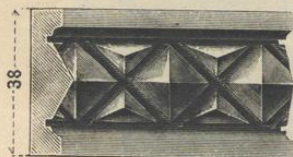

1.7 kg

Nr. 234

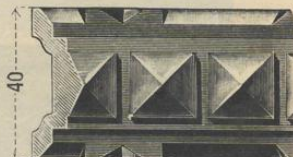

1.55 kg

Nr. 275

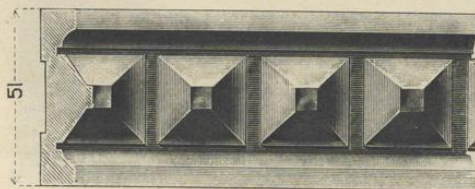

3.44 kg

Reliefeisen

Nr. 242



0.28 kg

Nr. 243



0.36 kg

Nr. 244

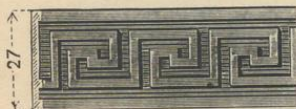

0.57 kg

Nr. 245

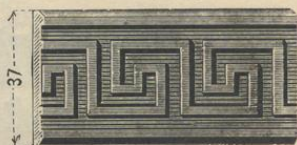

0.77 kg

Nr. 246

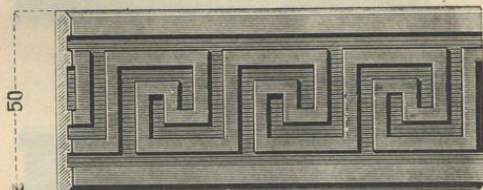

1.5 kg

Nr. 247

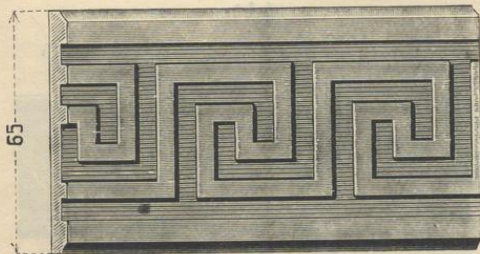

1.9 kg

Reliefeisen

Nr. 1529



0.27 kg

Nr. 883



0.43 kg

Nr. 692



0.36 kg

Nr. 1136



1.1 kg

Nr. 1080



1.1 kg

WM. SZALAY & SOHN, WIEN

Reliefeisen

Nr. 211

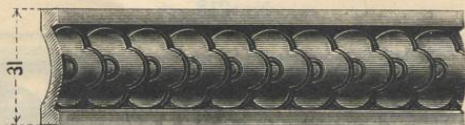

0.86 kg

Nr. 216

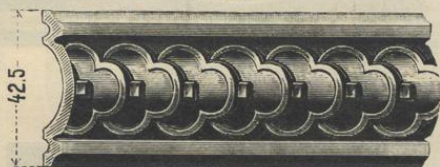

1.3 kg

Nr. 274

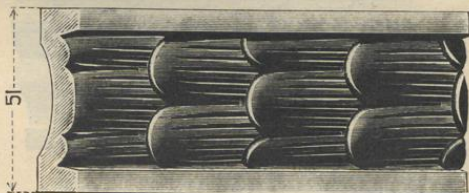

3.12 kg

Nr. 308

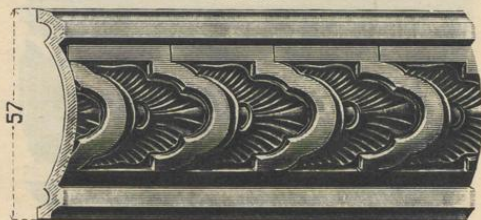

2.32 kg

WM. SZALAY & SOHN, WIEN

Reliefeisen

Nr. 218

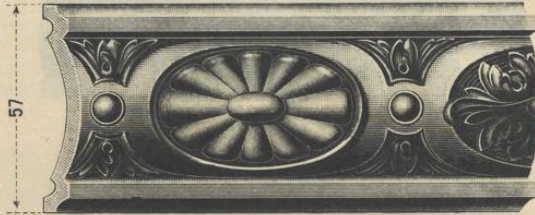

2·1 kg

Nr. 279

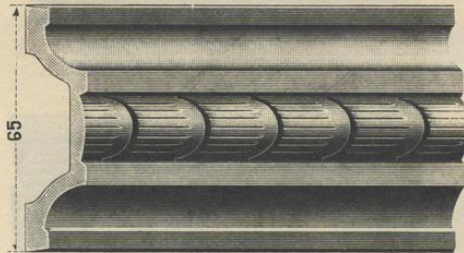

3·2 kg

Nr. 278

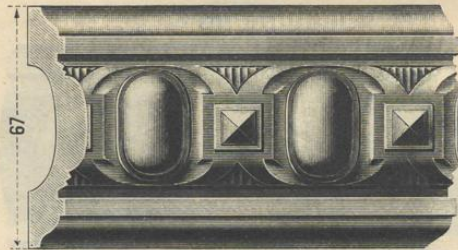

4 kg

WM. SZALAY & SOHN, WIEN

Reliefeisen

Nr. 280

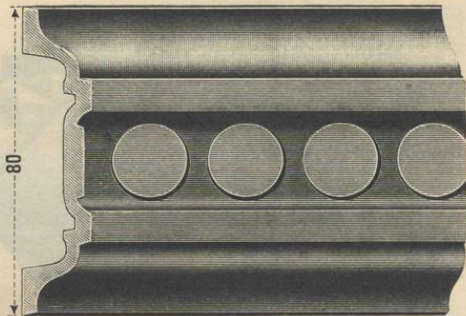

3.48 kg

Nr. 219

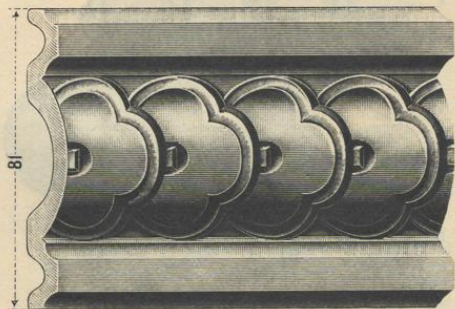

3 kg

WM. SZALAY & SOHN, WIEN

Reliefeisen

Nr. 281

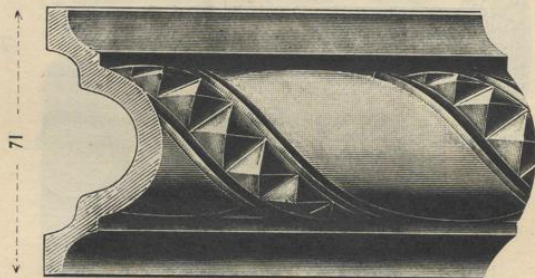

5.2 kg

Nr. 1555

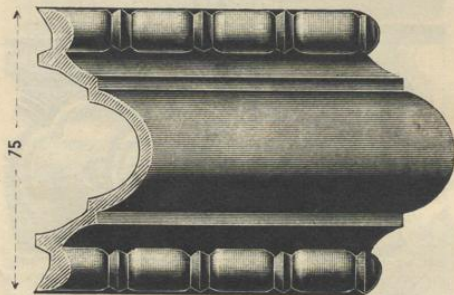

3.4 kg

WM. SZALAY & SOHN, WIEN

Reliefeisen

Ausgestanzte Zierstäbe

Nr. 1587

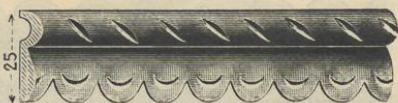

0.4 kg

Nr. 1588

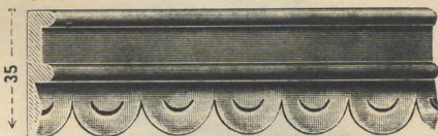

1.04 kg

Nr. 1573

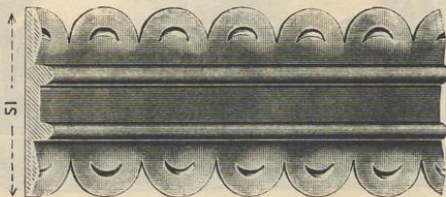

1.1 kg

WM. SZALAY & SOHN, WIEN

Reliefeisen

Ausgestanzte Zierstäbe

Nr. 1574

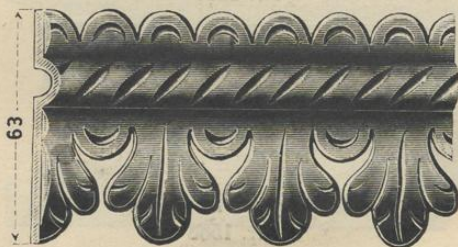

0.95 kg

Nr. 972



1.82 kg

Reliefeisen

Ausgestanzter Zierstab

Nr. 1635



2.56 kg

WM. SZALAY & SOHN, WIEN

WILHELM VON HUMBOLDT

1802

1802

WILHELM VON HUMBOLDT

Königsberg